



Ivy Home[™] Smart EV Charger

User Manual and
Installation Guide

Powered By
Grizzl-E[™]

Ivy Home™ Smart EV Charger

User manual and installation guide.
Manual revision: 1.0



Model Numbers:

Black
GRS-14-24-P

White
GRS-14-24-AB

Ivy Home Smart EV Charger

The Ivy Home Smart EV Charger is a sleek and stylish Level 2 EV Wi-Fi connected charger powered by Grizzl-E™. It is made in Ontario and designed to withstand the harshest Canadian weather conditions.

Ivy Home comes with a 24ft output cable and 24in NEMA 14-50 input cable. Internal design and components of the charger have been selected to maximize the operational life of the device.

The charger provides your electric vehicle with up to 10kW of power. Maximum current output can be set through DIP Switches to provide 16 Amps (A), 24A, 32A or 40A adjustable maximum current.

Important safety instructions

This document contains instructions and warnings that must be followed when installing and using The Ivy Home Smart Electric Vehicle Supply Equipment (EVSE). Before installing or using the EVSE, please read this document carefully including any WARNING and CAUTION symbols.

Symbol legend:



Warning: risk of personal injury



Warning: risk of fire



Warning: risk of electric shock



Caution: risk of damage to equipment

- This guide provides instructions for the home charger and should not be used for any other product. Before installation or use of this product, please review this manual carefully and consult with a licensed electrical contractor to ensure compliance with local building codes and safety standards.
- Ensure that the materials and the installation procedures follow local building codes and safety standards.

Basic precautions should always be followed when using electrical products, including the following:

- Read all the instructions before using this product.
- Children should not use this device. Keep out of reach of children.
- Do not put fingers into the EV connector.
- Do not touch live electrical parts.
- Do not use this product if the flexible power cord or EV cable is ragged, has broken insulation, or shows any other signs of damage.
- Do not use this product if the enclosure or the EV connector is broken, cracked, open, or shows any other indication of damage.
- Improper connection of the equipment grounding conductor can result in a risk of electric shock. Please check with a licensed electrician if you are in doubt as to whether the product is properly connected and grounded.

Repair and maintenance clause

- Even though this product does not require routine maintenance, periodic inspections are recommended to ensure that all parts remain and good working order and there is no damage.
- Do not attempt to disassemble, repair, tamper with, or modify any components of the product.



WARNING: This equipment is intended only for charging vehicles that do not require ventilation during charging. Please refer to your vehicle owner's manual to determine ventilation requirements.

Product features

The Ivy Home Smart EV Charger

- J1772 AC Level 2 (208-240 VAC), 40A Continuous Rated (9.6 kW).
- Adjustable maximum current output (40A, 32A, 24A, 16A) to support multiple circuit ratings (50A, 40A, 30A, 20A).
- Extreme duty, rigid & compact design.
- Heavy-duty aluminum cast enclosure; water resistant enclosure for indoor or outdoor use
- Wi-Fi connectivity and smart charging features.
- EasyEVplug™ holster or with cable management system.
- Plug-in configuration for easy portability.
- Wallmount with security features, including single stud mount, pedestal, bollard/pole single and dual port.
- UL certified.
- Energy star certified.

Adjustable maximum current output to support multiple circuit ratings

The Ivy Home EV Charger features the ability to adjust the maximum charger current output to allow the use of a 50A, 40A, 30A, or 20A dedicated circuit as follows:

- 50A circuit rating: max 40A (9.6kW) output
- 40A circuit rating: max 32A (7.68kW) output
- 30A circuit rating: max 24A (5.76kW) output
- 20A circuit rating: max 16A (3.84kW) output

The default factory setting is 40A (9.6kW). To change the maximum current output, refer to Chapter 3.1 Adjust maximum current output on page 11. If you are unsure of the circuit ratings in your home, consult a licensed electrical contractor.

Wi-Fi connectivity

The Ivy Home Smart EV Charger connects to Wi-Fi networks through the use of an ESP32 controller. Ivy Home is compatible with all OCPP 1.6 commands.

For more information on how to connect Ivy Home to a Wi-Fi network, see Chapter 8. Set up smart functionality on page 23.

Product specifications

Description	Specifications
Model Numbers	GRS-14-24-P GRS-14-24-AB
EVSE Level	SAE J1772; AC Level 2
Max Output Rating	40A; 9.6 kW Maximum Output – For use with 50A Circuit Rating
Alternate Adjustable Output Ratings	32A; 7.68 kW Maximum Output – For use with 40A Circuit Rating 24A; 5.76 kW Maximum Output – For use with 30A Circuit Rating 16A; 3.84 kW Maximum Output – For use with 20A Circuit Rating
Charge Cable Length	24 ft.
Electrical Circuit/Input Power Requirements	Circuit Requirement: Dedicated Single Phase 208-240VAC, 50/60 Hz.; Branch Breaker: Double pole; Circuit Conductors: Line 1, Line 2, Earth / Ground
Input Power Connection	Standard Plug-in: NEMA 14-50 Receptacle. Plug is removable for Hardwire Connection.
Installation Rating	NEMA 4X, Indoor/Outdoor Rated
Operational Ratings	Temperature: -22°F to 122°F (-30°C to 50°C); Humidity: 95% RH non-condensing
Mounting	Wall or Pedestal Installation
Overall Dimensions	EVSE: 10.25 x 6.25 x 3.75 inches (26.0 x 16.0 x 9.3 cm)
Overall Weight	21lbs (9.5kg)
Display & Indicators	LED Charge Status Indicators (Power/Ready, Charging, Fault)
Cable Management	EasyEvPlug™ with cable management
Standards & Compliance	UL Certified, Energy Star Certified

Table of Contents

1. Introduction & unpacking	8
1.1 Your charger	8
1.2 Package contents	9
2. Installation planning and service wiring.....	10
2.1 Electrical source requirements	10
2.2 Grounding instructions	10
3. Adjustable maximum current output.....	11
3.1 Adjust maximum current output.....	11
4. Installation	14
4.1 Tools & parts required for installation	14
4.2 Install the charging station	15
5. Input wiring connection (optional hardwire connection).....	18
6. EasyEvPlug holster and cable management system.....	20
7. Charging status indicators and buzzers	21
7.1 Charging status indicators	21
7.2 Fault indicators	22
7.3 Reset charger.....	22
8. Set up smart functionality.....	23
8.1 Network requirements.....	23
8.2 Connect the charger to Wi-Fi	23
8.3 Wi-Fi connection indicator.....	24
8.4 Troubleshoot connection errors.....	25
9. Disconnect from Wi-Fi.....	26
9.1 Reset Wi-Fi.....	26
10. Operation	27
10.1 Connect and charge	27
10.2 Smart charging	27
10.3 Stop charging	27
11. General product care and use information	28

1. Introduction & unpacking

1.1 Your charger

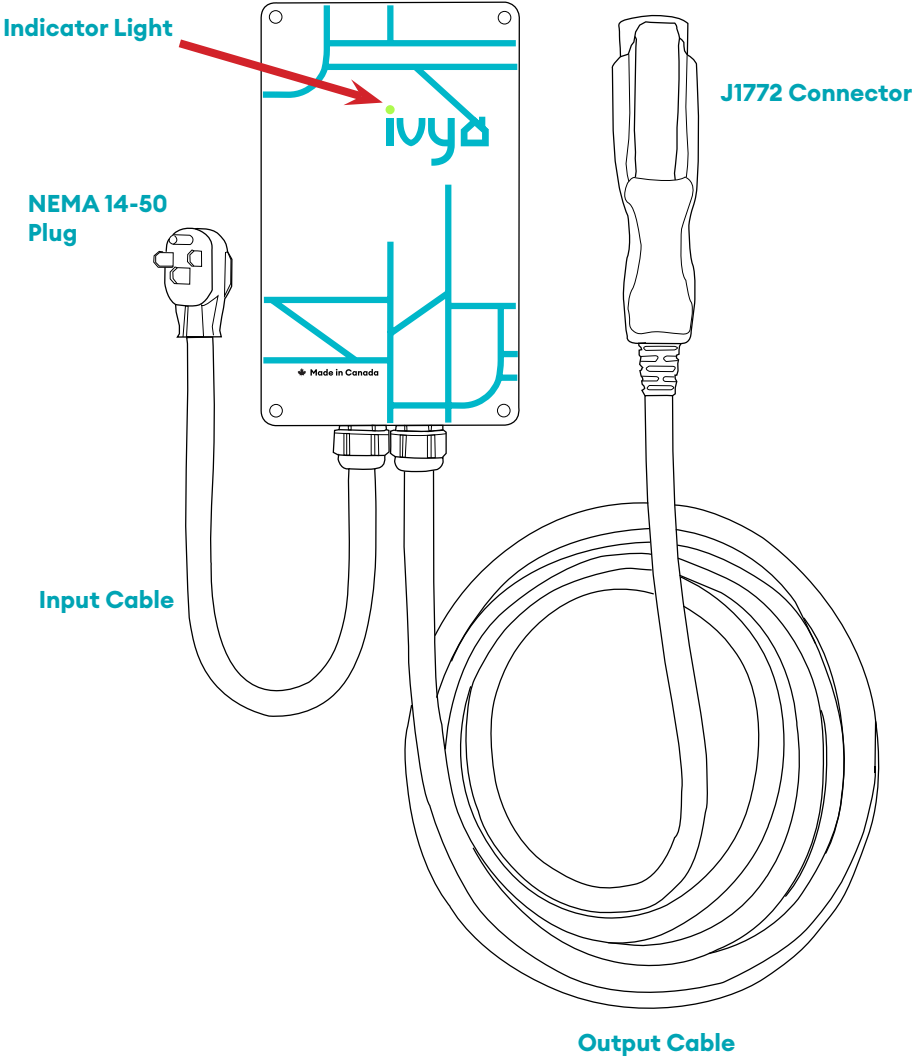

1.2 Package contents

Mounting Kit

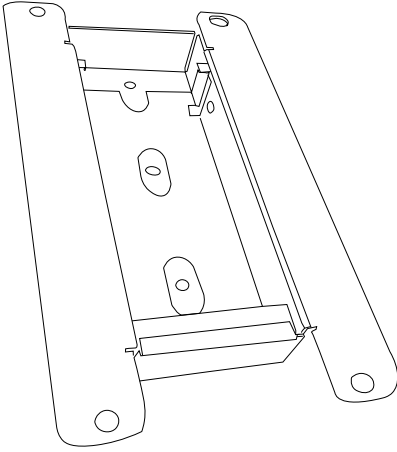

Mounting Bracket (x1)

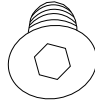

Socket Cap
Screw (x4)

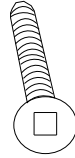

Robertson Head
Screws (x2)

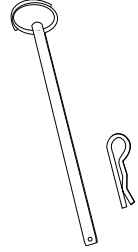

Security Pin (x1)

EasyEvPlug Holster

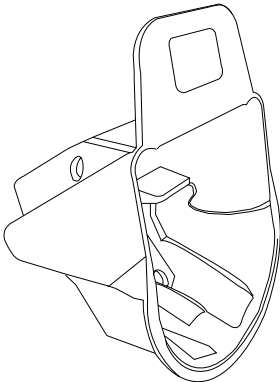

Holster (x1)

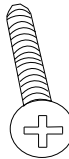

Phillips-head
Screws (x4)

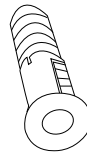

Anchor (x4)

2. Installation planning and service wiring



WARNING: Disconnect the power supply before installing, adjusting, or repairing the charger. Failure to do so may result in physical injury or damage to the power supply system and the charger.



CAUTION: To reduce the risk of fire, connect only to a circuit provided with the minimum branch circuit overcurrent protection requirements in accordance with the National Electrical Code ANSI/NFPA 7- and the Canadian Electrical Safety Code, Part 1, C22.1. If you are unsure if the circuit meets these requirements, consult a licensed electrician.

2.1 Electrical source requirements

- Prior to mounting, locate an available electrical source that can support the following input requirements for the charger per local Electrical Safety Code requirements:
 - » 40A maximum output setting (default factory setting): a DEDICATED CIRCUIT rated for 50A; 208-240 VAC, 50-60 Hz, Single Phase must be used.
 - » 32A maximum output setting (optional setting): a DEDICATED CIRCUIT rated for 40A; 208-240 VAC, 50-60 Hz, Single Phase must be used.
 - » 24A maximum output setting (optional setting): a DEDICATED CIRCUIT rated for 30A; 208-240 VAC, 50-60 Hz, Single Phase must be used.
 - » 16A maximum output setting (optional setting): a DEDICATED CIRCUIT rated for 20A; 208-240 VAC, 50-60 Hz, Single Phase must be used.
- A Double Pole Circuit Breaker of the circuit rating must be used.
- The charger has built-in GFCI protection. Additional GFCI protection upstream of the charger is not necessary. In locations where GFCI at the outlet is mandated by code, the charger will not experience negative effects.
- The charger can connect to a Standard NEMA 14-50 receptacle, or the unit can be hardwired.

2.2 Grounding instructions

The charger must implement equipment grounding through a permanent wiring system or an equipment grounding conductor. Use a cable with a dedicated grounding conductor connected to the equipment ground terminal block.

3. Adjustable maximum current output

The Ivy Home Smart EV Charger features the ability to adjust the maximum charging station current output to support 50A, 40A, 30A, or 20A dedicated circuit ratings as follows:

Circuit Rating	Maximum Charging Station Output
50A	40A (9.6 kW)
40A	32A (7.68 kW)
30A	24A (5.76 kW)
20A	16A (3.84 kW)

- The charger default factory maximum current output setting is 40A (9.6 kW) for use with a 50A Circuit Rating.
- The circuit must be a DEDICATED CIRCUIT 208-240 VAC, 50-60 Hz, Single Phase.
- Requirements govern that only 80% of the circuit rated load may be utilized, hence the higher Circuit Ratings Requirement relative to maximum charging station output.

3.1 Adjust maximum current output

To adjust the maximum current output setting:

1. Remove the front cover by removing the 4 screws at each corner of the charging station. Use a 5/32" (M4) Allen key to remove the screws.





CAUTION: The LED pipe is attached to the front cover. When the front cover is removed, place it on a flat surface facedown to avoid damage to the LED pipe.

2. With the front cover placed to the side, locate the DIP switch on the charging station circuit board. The DIP switch is a 4-position switch on the main circuit board, located directly to the left of the LED.

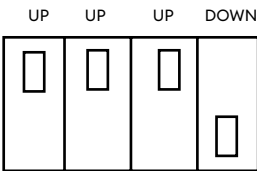

WARNING: Do not touch live electrical parts. Disconnect the power supply to the charging station before adjusting the DIP switches. Failure to do so may result in physical injury or damage to the power supply system and the charging station.

3. Adjust the maximum current output to either 40A, 32A, 24A or 16A, using the following combination of DIP switch settings:

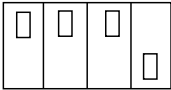
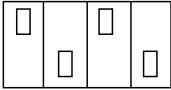
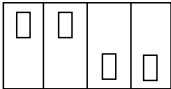
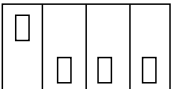
Maximum Current Output	Switch 1	Switch 2	Switch 3	Switch 4	DIP Switch Setting
40A Maximum Current Output (Factory Default Setting)	UP	UP	UP	DOWN	
32A Maximum Current Output	UP	DOWN	UP	DOWN	
24A Maximum Current Output	UP	UP	DOWN	DOWN	
16A Maximum Current Output	UP	DOWN	DOWN	DOWN	

4. Once the DIP switch setting is adjusted, reassemble the charging station. Reinstall the top cover to the charging station using the following torque force to secure the 4 socket cap screws:

Screw	Torque
5/32"	13.88 lbf-in (1.56Nm)

4. Installation

4.1 Tools & parts required for installation

Prior to mounting, determine the location of an acceptable mounting support. All charging station products must be anchored into a mounting support such as a 2" x 4" stud or a solid concrete wall. **DO NOT** mount this unit directly to a stucco/drywall/wall board.

Tool	Size	Source of Supply	Remark
Mounting bracket	10"x5.75"x1.25" (255x148x31 mm)	Included with product	For mounting the charger to the wall/structure
Socket cap screw (x4)	3/16" (M5)	Included with product	For securing the charger to the mounting bracket
Robertson-head screw (x2)	#14	Included with product	For installing the mounting bracket to the wall/structure
EasyEVPlug™ Holster	5"x3.5"x3.5" (127x89x89 mm)	Included with product	To store the EV charging plug and cable
Phillips-Head screw (x4)	#8	Included with product	For installing the EasyEVPlug™ to the wall/structure
Anchors (x4)	#8	Included with product	For installing the EasyEVPlug™ to the wall/structure
Philips screwdriver	PH3	Commercially available	For holder installation and optional hardwire install
Allen key	5/32" (M4)	Commercially available	For charging station cover screws
Allen key	3/16" (M5)	Commercially available	For installing the enclosure plate to the back of the station body

4.2 Install the charging station

1. Separate the front and back piece of the mounting bracket by pushing down on the notch.

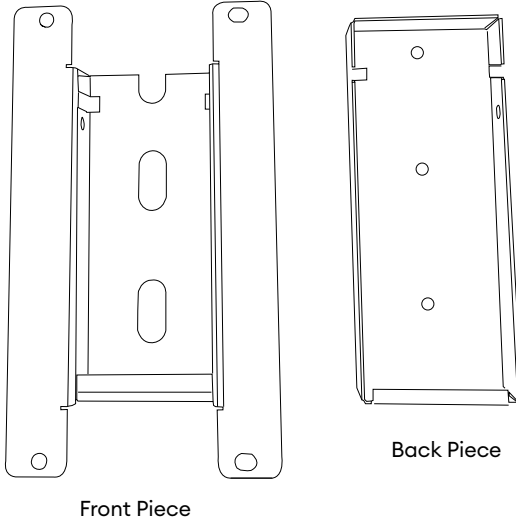

2. Attach the front piece of the mounting bracket to the back of the charging station using the socket cap screws. Ensure the top of the mounting bracket is matched with the top of the charging station.

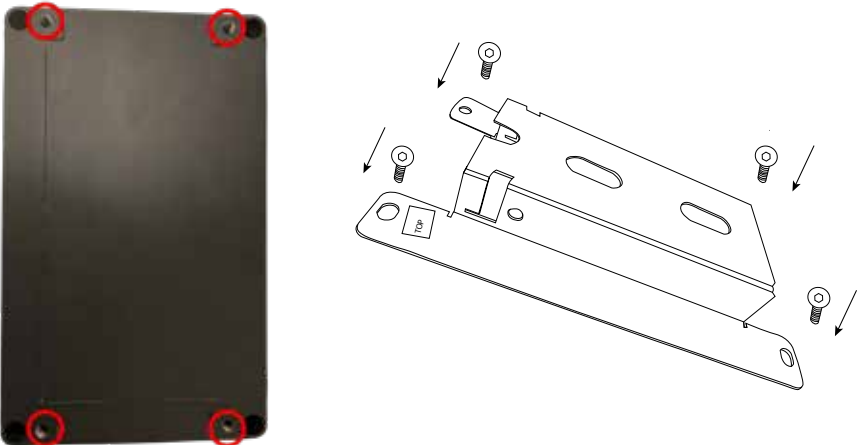

- Secure the back piece of the mounting bracket to the wall or other suitable structure using the Robertson-head screws.

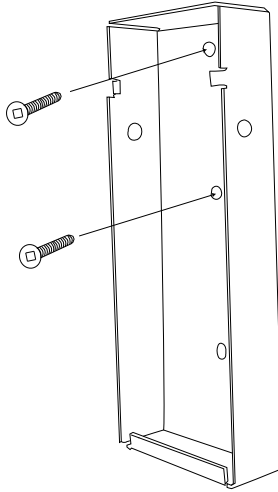

The back piece of the mounting bracket has 3 holes to support attachment to various surfaces. Use the top two holes to attach the mounting bracket to a wall stud.

Mounting screw recommendations:

- For finished walls supported by wood studs, use #14 or M6 tapping screws (included).
- For masonry walls, use M6 mechanical screws (commercially available).
- Use following torque force:

Screw	Torque	
M6	43.4 lbf-in	44.85Nm
1/4"	43.4 lbf-in	44.85Nm

The NEMA 14-50 cable is approximately 24" (30cm) long. Mount the unit so the NEMA 14-50 cable is straight but can be plugged into the outlet without stretching. The NEMA outlet should be located no less than 20-26" (50-60cm) from the ground or as defined by applicable, local electrical safety codes and standards.

4. Mount the charger on the wall by securing the front piece of the mounting bracket to the back piece of the mounting bracket.

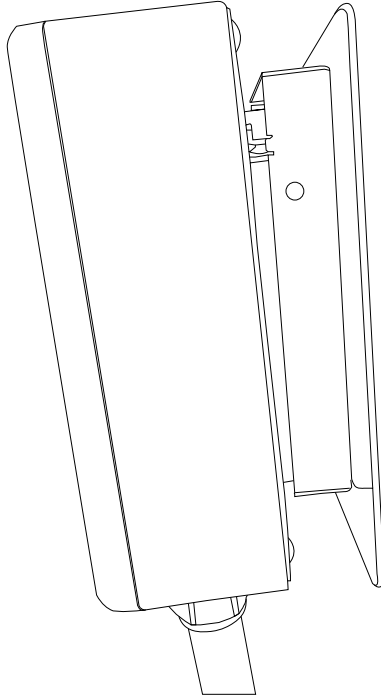

5. Secure the charger in place by inserting either the security pin or the outdoor security lock into the mounting bracket.
6. Plug in the power cord to the NEMA 14-50 wall outlet/receptacle. Ensure the indicator light alternates between Blue and Magenta, indicating the charger is ready and not connected to Wi-Fi.

5. Input wiring connection (optional hardwire connection)

1. Choose the appropriate conduit in accordance with all applicable, local, and electrical safety codes and standards.



2. Using the appropriate tool, clamp the ring wire terminal to the copper wire. For non-insulated terminals, use the heat shrink tube to cover the non-insulated portion of the terminal. Choose a terminal ring with the following characteristics:
 - » Recommended wire strip length: 8mm (0.32in)
 - » Width of the terminal block opening: 10.2mm (0.41in)



3. Remove the front cover by removing the 4 screws at each corner of the charging station. For more information on how to remove the front cover refer to Chapter 3.1 Adjust maximum current output on page 11.
4. With the front cover placed to the side, use a Phillips screwdriver to release terminal screws of the input cable. Loosen the strain relief fitting for the 14-50 plug and remove the plug.
5. Insert the wire end passing through the conduit and insert them into the input wiring hole. (Use Red wire for L1, Black wire for L2, Green wire for G). Attach the copper wire on the corresponding terminal block. Use the following wire and torque force when connecting to input terminal block.

Terminal	Conductor	Screw	Rating	Torque
L1, L2, G	6-8 AWG	M4	75C, copper wire	16 lbf/in 1.8Nm





CAUTION: To reduce the risk of fire, connect only to a circuit provided with the appropriate amperes minimum branch circuit overcurrent protection in accordance with the National Electrical Code, ANSI/NFPA 70, and the Canadian Electrical Code, Part I, C22.1.

- Once the input wiring and conduit are connected, reassemble the charger. Reinstall the charger front cover using the following torque force to secure the (4) screws:

Screw	Torque
5/32"	13.88 lbf in (1.56Nm)

6. EasyEVPlug holster and cable management system

The EasyEVPlug Holster or Tesla EasyEVPlug Holster is the new innovative method to protect your plug and manage your cord. It includes the following features:

- No need to aim – flawless plug even in the dark.
- Always in a convenient location.
- Saves space – special angle for less wall clearance.
- Integrated cable management – holds up to 25 feet of cable.

The EasyEVPlug holster can be installed at any location near the charging station.

1. Hold back of holster against the mounting surface. Fasten Phillips head screws through back holes. Use anchors if attaching directly to drywall.

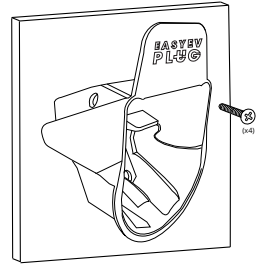

2. Insert charging connector into holster.

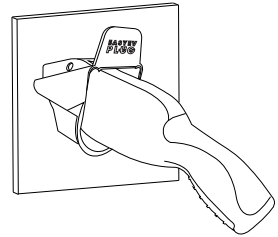



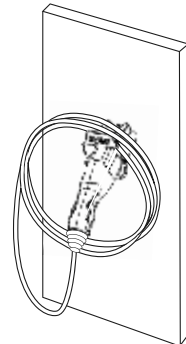







3. Wrap cable on top of EasyEVPlug.



7. Charging status indicators and buzzers

7.1 Charging status indicators

The following status indicators will be used:

LED Indicator	Buzzer	Description	Definition
	No Buzzer	Not illuminated	Power Off
	No Buzzer	Red Steady	Initialization
	No Buzzer	Blue + Magenta Alternating	Charger Ready + Not Connected to Wi-Fi
	No Buzzer	Blue + Cyan Alternating	Charger Ready + Connected to Wi-Fi
	No Buzzer	Blue + White Alternating	Vehicle detected + Wi-Fi Initialization
	No Buzzer	Blue Flashing	Vehicle Detected
	No Buzzer	Green Flashing	Charging in progress
	No Buzzer	Green Steady	Charging complete or no current consumed by the car
	No Buzzer	White Flashing	Ocpp Network issued Stop Charge Command
	Buzzer Beeps	Red Flashing	Fault (See Chapter 7.2 Fault indicators on page 22)

***Note:** After power-up, Wi-Fi will initiate the first time the charger is plugged into the vehicle. It may take up to 30 seconds for charging to begin during initialization.

7.2 Fault indicators

The number of red flashes indicates the type of fault:

LED Indicator	# of Flashes	Error Description
Red Flashing	1	Lost ground - AC Line1
Red Flashing	2	GFCI High Leakage
Red Flashing	3	Relay is stuck
Red Flashing	4	GFCI Low Leakage
Red Flashing	5	High temperature of the module
Red Flashing	6	High temperature of the relay
Red Flashing	7	Pilot state is Status E
Red Flashing	8	Pilot state is Status F
Red Flashing	9	Diode error
Red Flashing	10	Over Current
Red Flashing	12	Application Error

7.3 Reset charger

In the instance of a fault, it is recommended that you perform a reset:

1. Count the number of flashes to identify the error type.
2. Unplug the charging connector from your EV.
3. Turn off the power to the charger by switching the upstream circuit breaker to the “OFF” position or unplug the charger.
4. Wait 1-2 minutes and then switch the upstream circuit breaker back to the “ON” position or plug in the charger.
5. Confirm the fault light is no longer present.
6. If the fault light remains, please contact Ivy Customer Support at 1-800-301-1950.

8. Set up smart functionality

8.1 Network requirements

The Ivy Home Smart EV Charger will perform best with a stable and strong Wi-Fi internet connection.

Weak or unstable internet connections can limit performance of EV charger and prevent communication with the vehicle.

Basic requirements

- ✓ 2.4 GHz band Wi-Fi Network (Not 5 GHz)
- ✓ Signal strength of -67 dBm or greater where the charger is located
- * Some firewalls may prevent or disrupt charger communication

8.2 Connect the charger to Wi-Fi

Connect to Ivy app

Follow these steps to connect to Wi-Fi and add your charger to your account:

1. Download the Ivy App from the Google Play Store or Apple App store.
2. Sign up for an account.
3. In the Ivy App, select the My Charger screen.
4. Select **Add My Charger**.
5. Select **Ivy Home powered by Grizzl-E** as the Manufacturer and **Ivy Home Smart Charger**
- 6. [Black or White]** as the Model.
7. Select the **Next** button.
8. Exit the Ivy App and go to your Wi-Fi Settings.
9. Connect to the Network **UC_Smart_ChargerSerial###**.
10. Go back to the Ivy app. The app will verify that you are connected to the charger's network.
11. Select your Wi-Fi network from the list of available networks.
12. Enter the Wi-Fi Password and confirm the password.
13. Select the **Next** button.
14. Wait for the app to connect and register the charger. Do not close the app or run in the background while the setup process is occurring.

8.3 Wi-Fi connection indicator

If the connection is successful, the Wi-Fi network **UC_Smart_[ChargerSerial#]** will no longer be discoverable and the indicator light on the charger will alternate between Blue and Cyan.

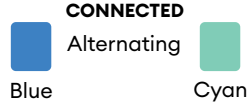

If the connection is unsuccessful, the Wi-Fi network **UC_Smart_[ChargerSerial#]** will be visible on devices and the indicator light on the charger will alternate between Blue and Magenta.

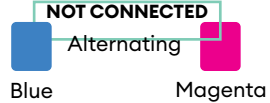

8.4 Troubleshoot connection errors

If the charger is not connecting to the network ensure the following:

- Ensure network frequency is 2.4ghz.
- Ensure that signal strength is adequate.
- Ensure Wi-Fi Password is correct.
- Check if Network Filters/Firewalls are blocking charger communication

2.4 GHz band Wi-Fi network

The Ivy Home Smart EV Charger only connects to a 2.4ghz Wi-Fi frequency. Ensure your network has a dedicated 2.4ghz Wi-Fi band with its own SSID.

Before connecting the charger, check the network frequency in network properties on your PC or Android.

For Dual Band 2.4ghz/5ghz Routers do one of the following:

- Create a separate SSID for the 2.4ghz and 5ghz network. For example, *network_name_2.4G* and *network_name-5G*.
- For routers that have the ability, turn off 5G band and connect to 2.4ghz band.
- Install a 2.4ghz Wi-Fi extender with a separate extension network for the charger.

Signal strength

Ensure a Wi-Fi signal strength of -67 dBm or greater where the charger is located.

Check your location's Wi-Fi signal strength to ensure a quality EV charging experience. You can use third-party mobile apps available to test the strength. Use your smartphone camera to scan the QR code for options. Ivy does not maintain these apps and cannot guarantee their effectiveness or security.

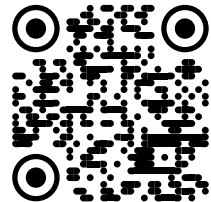

Signal strength (cont'd)

For locations that don't have a sufficiently strong Wi-Fi signal, follow one of the steps below to improve signal quality:

1. Move the Wi-Fi router as close to your EV charger as possible for the simplest solution.
2. Wi-Fi repeaters or extenders can boost the signal of existing access points.
3. Multiple access points may be required to provide network coverage.

Password

Ensure the Wi-Fi Password entered matches the Wi-Fi network settings exactly. The charger will recycle the connection if password information is incorrect.

The password limit for the charger is 38 characters. The charger will not connect to Wi-Fi networks with passwords longer than this limit.

Network Filtering/Firewalls

Some firewalls may prevent or disrupt charger communication. Check the blocked clients list in your router settings to see if a Network Filter is blocking the charger. Follow the directions for your router to access the list of blocked clients. The charger will appear on the client list as **esp32-arduino**.

9. Disconnect from Wi-Fi

9.1 Reset Wi-Fi

To reset the Wi-Fi on the Ivy Home Smart EV Charger, follow the steps below:

1. Unplug the charger.
2. Remove the front cover by removing the 4 screws at each corner of the charging station. For more information on how to remove the front cover, refer to Chapter 3.1 Adjust Maximum Current Output on page 10.
3. With the front cover placed to the side, locate the DIP switch on the charging station circuit board. The DIP switch is a 4-position switch on the main circuit board, located directly to the left of the LED.
4. Move the DIP Switch #1 to the down position. This applies to all 40A, 32A, 24A amperage settings. For 16A, set DIP #2 to the up position to set the charger to 20A before proceeding.

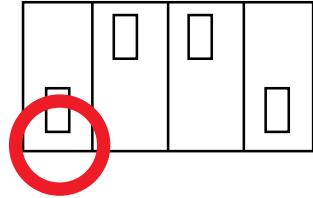

5. Plug the charger back in. Wait 2 minutes. Ensure the indicator light is Blue/Magenta alternating with 1-second frequency.
6. Unplug the charger again.
7. Set the DIP switch back to the original position.
8. Plug the charger in. It will display the Blue/Magenta alternating indicator light.
9. Follow the instructions from Chapter 8. Set up smart functionality on page 23 to reconnect to your Wi-Fi network and OCPP Network.
10. Replace the enclosure lid by tightening the 4 screws at each corner.

10. Operation

10.1 Connect and charge

Insert the charging connector into the EV and ensure the connector is fully seated/locked in place. Once complete, the charging session will begin.

Charging will start in both Connected Mode (Cyan indicator LED) and Standard Mode (Magenta indicator LED).

Note: It may take up to 30 seconds for charging to start as unit and Wi-Fi initialize.

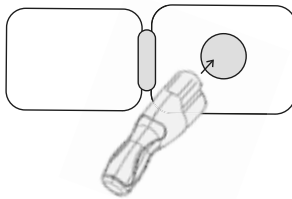

10.2 Smart charging

To initiate smart charging features such as scheduling, follow the instructions on the My Charger tab in the Ivy app.

10.3 Stop charging

1. Unplug the charging station by pressing the connector button and removing the charger connector from the EV (once the connector button is depressed, the charging session terminates immediately).
2. Return the connector to the holster.

11. General product care and use information

The exterior of the charging station is designed to be waterproof and dust proof (NEMA 4 Outdoor Rated). However, periodic cleaning may be required, depending on local conditions. To ensure proper maintenance of the charging station, follow these guidelines:

- To avoid damaging the finish of the products, only use an automotive grade soft cleaning cloth with soap and water to remove accumulated dirt and dust. Do not use cleaning solvents to clean any of the product components.
- Despite the water resistance of the enclosure, submerging the unit in water is not recommended.
- Ensure the charging connector is put back in the holster after charging to avoid damage.
- If the output cable or the J1772 charging connector is damaged, turn off the charging station supply circuit breaker, do not use the charging station, and contact Ivy Customer Support for replacement parts at 1-800-301-1950.
- When moving or lifting the unit, always grasp and carry by the charging station body. Never attempt to lift, move, or carry the unit by any of the electrical cables. Improper handling may cause damage to the unit.